

Roof Coating , Caulks & Sealants

High Quality

KOOL SEAL



| | | |
|-------|--------|--|
| 10013 | Gal. | |
| 10012 | 5 Gal. | |

Premium

KOOL SEAL



| | | |
|-------|--------|--|
| 10003 | Gal. | |
| 10001 | 5 Gal. | |

White Elastomeric

KOOL SEAL



| | | |
|-------|--------|--|
| 15482 | Qt. | |
| 15483 | Gal. | |
| 15484 | 5 Gal. | |

Flexx Sealer

KOOL SEAL



| | | |
|--------|----------|--|
| 181500 | 2" x 10' | |
| 18125 | 4" x 4' | |
| 18200 | 4" x 12' | |

Black Patching Cement

KOOL SEAL



| | | |
|-------|-----|--|
| 14766 | Qt. | |
|-------|-----|--|

White Patching Cement

KOOL SEAL



| | | |
|-------|------|--|
| 10052 | Tape | |
| 12251 | Qt. | |
| 12250 | Gal. | |

Glass Fabric Membrane

KOOL SEAL



| | | |
|-------|----------|--|
| 10042 | 4" x 40' | |
|-------|----------|--|

Wet & Dry Cement

JETCOAT



| | | |
|-------|--------|--|
| 10009 | 1 Gal. | |
| 10014 | 5 Gal. | |

Black Plastic Roof Cement

MONSEY



| | | |
|-------|--------------|--|
| 16322 | 11 oz. Cart. | |
|-------|--------------|--|

Wood Slip Brush & Handle



| | | |
|-------|------------|--|
| 10022 | 60" Handle | |
| 10029 | 7" Brush | |

Threaded Brush & Handle



| | | |
|--------|------------|--|
| 18889 | 48" Handle | |
| 18889L | 60" Handle | |
| 18890 | 7" Brush | |

Dyco 20/20



Metal Roofs Only!

| | | |
|-------|--------|--|
| 10019 | 11 oz. | |
| 10010 | Qt. | |
| 10018 | Gal. | |

Dicor



| | | |
|------|--------|--|
| 9999 | 11 oz. | |
| 9997 | Qt. | |
| 9998 | Gal. | |

Rubber Roof Repair



| | | |
|----------------------------|------|--|
| Primer 50 Sq. Ft./ Gallon | | |
| 10005 | Gal. | |
| Top Coat 80 Sq. Ft./Gallon | | |
| 10006 | Gal. | |

ProTec RV



Rubber Roof Care System

| | | |
|-------|------------|--|
| 16561 | Repair Kit | |
|-------|------------|--|

ProTec RV Repair Kit



| | | |
|-------|--|--|
| 41461 | | |
|-------|--|--|

Rubber Roof Adhesive



| | | |
|------|----------------------|--|
| 1671 | (Rubber/Rubber) Qt. | |
| 1638 | (Rubber/Fiber.) Gal. | |
| 8011 | (Rubber/Wood) Gal. | |

ProFlex RV Sealant



10 oz.

| | | |
|-------|-------|--|
| 10015 | Clear | |
| 10016 | White | |

Instant Roof Repair



| | | |
|-------|-----|--|
| 10017 | Qt. | |
|-------|-----|--|

Liquid Rubber Roof



Coverage: 42 Sq.Ft / Gallon

| | | |
|-------|----------|--|
| 18011 | Gal. | |
| 18009 | 5 Gal. | |
| 18013 | Gal. Kit | |

One gallon Can, with safety ring on lid
Bottle of pre-measured catalyst
Mixer & Shaft & 10 foot roll fabric
2 1/2 inch bristle brush

Kit Contains:

Rubber Roof Kit



| | | |
|--------|-----------|--|
| 1541RR | 15' x 41' | |
| 1566RR | 15' x 66' | |
| 1571RR | 15' x 71' | |
| 1576RR | 15' x 76' | |

Kit Contains:
Term Bar, Vinyl Insert, Caulk, Screws & Butyl Tape

Roof Vent Flashing

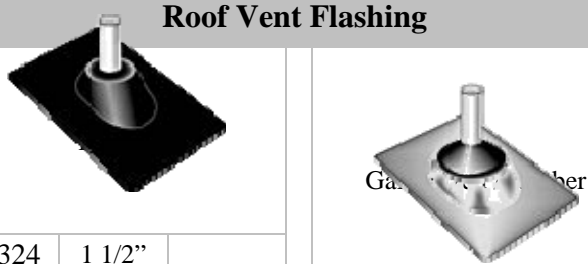

| | | |
|-------|--------|--|
| 13324 | 1 1/2" | |
| 13325 | 2" | |
| 13326 | 3" | |

| | | |
|-------|----|--|
| 81865 | 4" | |
|-------|----|--|

Galvanized Roofing



Call for Quote

| | | |
|-------|-------------|--|
| 19900 | Per sq. ft. | |
|-------|-------------|--|

Aluminum Flashing



| | | |
|-------|-----------|--|
| 14973 | 8" x 50' | |
| 14972 | 14" x 50' | |

Rumble Buttons



| | | |
|--------|--------|--|
| 10050 | 1 1/8" | |
| 10050M | 3/4" | |

All Prices Subject To Change At Any Moment WITHOUT NOTICE!

| Putty Tape | | |
|---|------------------|--|
|  | | |
| 11918 | 3/4" x 5' | |
| 10025 | 3/4"x30' 24/Case | |
| 10026 | 1"x30' 20/Case | |

| Butyl Tape | | |
|---|------------------|--|
|  | | |
| 10057 | 3/4"x30' 24/Case | |
| 10069 | 1"x30' 20/Case | |

| Black Electrical Tape | | |
|---|-------------------|--|
|  | | |
| 10060 | 3/4"x60' 10/Bndl. | |

| Package Tape | | |
|---|-----------|--|
|  | | |
| 15962 | 2" x 165" | |

| Duct Tape | | |
|---|-----------------|--|
|  | | |
| 10055 | 1.87" x 30' | |
| 10054 | 2"x180' 24/Case | |

| Black Bottom Board Tape | | |
|---|-----------------|--|
|  | | |
| 10056 | 2"x180' 24/Case | |

| Aluminum Foil Tape | | |
|--|-----------|--|
|  | | |
| 10068 | 2" x 30' | |
| 10059 | 2" x 150' | |

| UL Approved Foil Tape | | |
|--|----------|--|
|  | | |
| 339 | 1" x 50' | |

| Transport Plastic Tape | | |
|--|-----------|--|
|  | | |
| 10070 | 4" x 108' | |

| Weather Strip | | |
|---|--------------|--|
|  | | |
| 10778 | 1/8" x 1/4" | |
| 10786 | 1/4" x 3/8" | |
| 10779 | 3/8" x 3/16" | |
| 10785 | 3/8" x 1/2" | |
| 10787 | 3/4" x 3/16" | |

| Double Sided Foam Sealant Tape | | |
|--|--------------|--|
|  | | |
| 9559 | 1/16" x 3/8" | |

| Cap Tape | | |
|---|--------------|--|
|  | | |
| 10067 | 1 1/2" x 30' | |

| Teflon Tape | | |
|---|-------------|--|
|  | | |
| 10058 | 1/2" x 43'+ | |

| Glo Flagging Tape | | |
|---|----------------|--|
|  | | |
| 16453 | 1 3/16" x 150' | |

| Reflective Tape | | |
|---|-----------------|--|
|  | | |
| 10051 | D.O.T. Approved | |

| Silicone Caulk | | |
|---|-------|--|
|  | | |
| 12/ct. | | |
| 10033 | White | |
| 10034 | Clear | |

| Acrylic w/Silicone Caulk | | |
|---|--------|--|
|  | | |
| 12/ct. | | |
| 10034P | White | |
| 10034PA | Almond | |
| 10034PC | Clear | |

| Tub & Tile | | |
|---|--------|--|
|  | | |
| 12/ct. | | |
| 14770W | White | |
| 14770C | Clear | |
| 14770 | Almond | |

| Acrylic Caulk | | |
|---|-------|--|
|  | | |
| 12/ct. | | |
| 10030 | White | |

| Caulk Gun | | |
|---|--|--|
|  | | |
| 15127 | | |

| Tub & Tile | | |
|---|--------|--|
|  | | |
| 10035 | White | |
| 10035A | Almond | |

| Liquid Nails for Projects | | |
|---|--------|--|
|  | | |
| 12090 | 24/ct. | |

| Construction Adhesive | | |
|---|--|--|
|  | | |
| 10037 | | |

| Permanent Sealer | | |
|---|--|--|
|  | | |
| 14776 | | |

| Red RTV Silicone | | |
|---|-------|--|
|  | | |
| 32603 | 3 oz. | |

| Fire Stop Silicone | | |
|---|--|--|
|  | | |
| 76001 | | |

| WD-40 | | |
|--|--------|--|
|  | | |
| 11611 | 11 oz. | |

| Plumber's Goop | | |
|---|---------|--|
|  | | |
| 11617 | 3.7 oz. | |

| Spray Foam | | |
|---|--|--------|
|  | | |
| 14961 | | 12/ct. |

| Spray Adhesive | | |
|---|--|--------|
|  | | |
| 12045 | | 12/ct. |

| Spray Silicone | | |
|--|--|--------|
|  | | |
| 11609 | | 12/ct. |

| 4 Minute Epoxy | | |
|---|--------|--|
|  | | |
| 29800 | 1 Gram | |

| Rapid Repair Putty | | |
|---|--------|--|
|  | | |
| 11615 | Almond | |
| 11618 | White | |

| Fiberglass Repair Kit | | |
|---|--|--|
|  | | |
| 923 | | |

| Super Glue | | |
|--|-------|--|
|  | | |
| 922 | 2 pk. | |

| PC-7 Epoxy | | |
|---|-------|--|
|  | | |
| 2777 | 2 oz. | |
| 2554 | 1 oz. | |

All Prices Subject To Change At Any Moment WITHOUT NOTICE!

#8 Hex Head Screws

|  | Zinc-Plated | | | | | | Painted White | | | | | |
|---|------------------------|--------|--|---------------|--------|--|---------------|--------|--|---------------|--------|--|
| | Boxes of 100 | | | Boxes of 1000 | | | Boxes of 100 | | | Boxes of 1000 | | |
| | 15369EA | 1/2" | | 15369 | 1/2" | | 15381EA | 1" | | 15381 | 1" | |
| | 15370EA | 3/4" | | 15370 | 3/4" | | 15380EA | 1 1/4" | | 15380 | 1 1/4" | |
| | 15371EA | 1" | | 15371 | 1" | | 15387EA | 1 1/2" | | 15387 | 1 1/2" | |
| | 15372EA | 1 1/4" | | 15372 | 1 1/4" | | 15383EA | 2" | | 15383 | 2" | |
| | 15373EA | 1 1/2" | | 15373 | 1 1/2" | | Painted Brown | | | Painted Black | | |
| | 15374EA | 2" | | 15374 | 2" | | Boxes of 100 | | | Boxes of 100 | | |
| | Painted Colonial White | | | | | | 15382EA | 1" | | 15386EA | 1" | |
| | 15377EA | 1" | | 15377 | 1" | | 15384EA | 2" | | 15385EA | 2" | |
| 15388EA | 2" | | | | | | | | | | | |

#8 Aluminum Hex Head

| Boxes of 50 | | |  | Boxes of 400 | | |
|-------------|--------|--|---|--------------|--------|--|
| 15391EA | 3/4" | | | 15391 | 3/4" | |
| 15392EA | 1" | | | 15392 | 1" | |
| 15393EA | 1 1/4" | | | 15393 | 1 1/4" | |

#10 Self Drilling Hex Head

| Boxes Of 100 | | |  |
|--------------|------|--|---|
| 801379 | 3/4" | | |
| 801380 | 1" | | |
| | | | |

Flat Head

| Boxes of 100 | | |  | Boxes of 1000 | | |
|--------------|--------|--|---|---------------|--------|--|
| 15397EA | 1" | | | 15401 | 2" | |
| 15398EA | 1 1/4" | | | 15403 | 2 1/2" | |
| 15399EA | 1 1/2" | | | 15404 | 3" | |
| 15401EA | 2" | | | 15407 | 5" | |
| 15403EA | 2 1/2" | | | | | |
| 15404EA | 3" | | | | | |
| 15406EA | 4" | | | | | |

#6 Drywall Screws

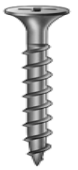
| 290 Pk. | | |  |
|----------|--------|--|---|
| 802139 | 1 1/4" | | |
| 1450 Pk. | | | |
| 802140 | 1 1/4" | | |

Lag Screw & Washer

| Sold Separately Special Pricing in 300 ct. Box | | |  |
|---|-----------|--|---|
| 15545 | 3/8" x 5" | | |
| 15546 | 3/8" x 6" | | |
| 15547 | 3/8" x 7" | | |
| Washer Only Special Pricing in 3,350 ct. Box | | | |
| 15548 | | | |
| | | | |

Washer Head

| Boxes of 100 | | |  | Boxes of 1000 | | |
|--------------|--------|--|---|---------------|--------|--|
| 15418EA | 1 1/4" | | | 15416 | 3/4" | |
| 15419EA | 1 1/2" | | | 15417 | 1" | |
| 15421EA | 2" | | | 15418 | 1 1/4" | |
| 15423EA | 2 1/2" | | | 15419 | 1 1/2" | |
| 15424EA | 3" | | | 15423 | 2 1/2" | |
| | | | | 15424 | 3" | |

White Screw Cover

| | | | |
|------|--|--|---|
| | | |  |
| 1746 | | | |

Rumble Buttons

| | | |
|--------------------------|---|--------|
| 3/4" Includes 3/4" Screw |  | 1 1/8" |
| 10050M | | 10050 |

Phillips Head Bit



| | | |
|-------|---------|--|
| 15232 | #1 | |
| 15233 | #2 | |
| 15569 | #1 Long | |
| 15234 | #2 Long | |

Flat Head Bit



| | | |
|-------|---------|--|
| 15229 | #1 | |
| 15230 | #2 | |
| 15231 | #1 Long | |
| 15254 | #2 Long | |

5/32" Clutch Head Bit



| | | |
|-------|-------|--|
| 14689 | Short | |
| 14690 | Long | |

Square Recess Head Bit



| | | |
|-------|-----------|--|
| 14514 | #1 | |
| 14515 | #2 | |
| 12376 | #1 Long | |
| 15487 | #2 Long | |
| 15488 | #2 X-Long | |

Magnetic Nut Setter



| | | |
|-------|-----------------|--|
| 14832 | 1/4" x 1 3/4" | |
| 14833 | 5/16" x 1 3/4" | |
| 14834 | 3/8" x 1 7/8" | |
| 14842 | 7/16" x 1 7/8" | |
| 14835 | 1/4" x 2 9/16" | |
| 16327 | 5/16" x 2 9/16" | |

Magnetic Nut Setter



Tapered Head

| | | |
|-------|-----------|--|
| 16324 | 1/4" x 2" | |
|-------|-----------|--|

Bit Holder



| | | |
|-------|-----------|--|
| 15228 | 1/4" x 3" | |
|-------|-----------|--|

Clutch Head Driver



| | | |
|-------|-------|--|
| 14087 | 5/32" | |
|-------|-------|--|

Nut Driver



| | | |
|-------|------|--|
| 14091 | 1/4" | |
|-------|------|--|

Screwdrivers



| | | |
|-------|--|--|
| 14093 | | |
|-------|--|--|

Square Head Driver



| | | |
|-------|----|--|
| 14827 | #2 | |
|-------|----|--|

5&1 Screwdriver



- * #1 Square
- * #2 Square
- * #1 Phillips
- * #1 Slotted
- * 5/32 Clutch

| | | |
|-------|--|--|
| 14830 | | |
|-------|--|--|

Hex Head Driver



| | | |
|-------|-------|--|
| 16329 | 5/16" | |
|-------|-------|--|